

*Our Protection.
Your Benefit.*

SIBA

F U S E S



**Expanded PV &
Energy Storage
(ES) Systems**



Phone: 1-973-575-SIBA (7422) ♦ Fax: 1-973-575-5858
Email: info@sibafuse.com ♦ Web: www.siba-fuses.us





Product Overview

HH - High Voltage Fuses International Standards for Indoor / Outdoor / Oil Submersible for AC and DC applications DIN / IEC Standards.

Power: HV (high Voltage) fuses from 2.4kV to 40.5kV. Transformer / Motor / Capacitor Protection. Siba HV fuses: Current Limiting - Full Range (True Full Range) - General Purpose - Back-UP. SIBA HV fuses are available with striker pins of force: 50N, 80N & 120N. All SIBA 80 N striker pin systems are fitted with an integral Temperature Limiter. Accessories: Fuse base In/Out Door, clips and insertion/removal tool.



Transformer / Motor
Din Style R-Rated



Capacitor Protection
HHA American Standard



Under Oil and Motor
HHB British Standard



For PT and Under Oil
SSK Wind-Power/Low Losses



Full Range Fuses

UR - Ultra Rapid® Fuses For Rectifiers, Inverters and Photovoltaic Systems. UL Recognized, UL Listed



URDC PV Solar Photovoltaic
250VDC - 1500VDC



URZ Cylindrical
250VAC - 1000VAC



URS Square Body
500VAC - 2500VAC

Over many decades, SIBA has developed a comprehensive product line of Ultra Rapid® fuses with worldwide acceptance. SIBA's worldwide distribution network provides technical support, and with our R&D Engineering Department, provides design partnerships for the development of new products with the most modern equipment for the design, manufacturing, and testing, to minimize development time.



URB Size 000 & 00 DIN80
600VAC - 1000VAC



URD ND & D
440VAC - 500VAC



URDC DC Fuses
440VDC - 5000VDC



URE British Standard
240VDC - 700VDC



URL Combination
690VAC - 700VAC



URM German Style Knife Blade
690VAC - 2000VAC

DC Sizes: 10x38mm, 14x51mm, 22x58mm, 27x60mm, 20x127mm, 20x190mm, 36x190mm, 40x254mm, NH000 DIN80, SQB-DC0 & 2, SQB-DC2-2 (double), SQB-DC90, 1, & 2, SQB DC92-2 (double body), SQB-DC93, SQB-DC93-2 (double body), NH3, NH4.



URDC PV Solar Photovoltaic 250 VDC - 1500 VDC



UL Listed to 248-19

Siba Fuses is the world leader in PV Protection, Combiner & Inverters. 1500 VDC PV.



URS Square Body 500VAC - 2500VAC

SQB Size 1, 2, 3, 4 & Press Packs. UL & IEC. 690-2500VAC. UNC & Metric Thread.



G - Miniature Fuses

SMD Miniature Cylindrical, KS, Holders & Clips. Pigtail & Panel Mount. UL / IEC / VDE / EC.



Phone: 973-575-7422
Fax: 973-575-5858
Email: info@sibafuse.com

SIBA LLC
29 Fairfield Place
West Caldwell, NJ 07006 USA



Solar Fuses

Product Overview

URPV UL 248-19 		SIBA PV Fuse Offering	
Article Number	Description		Image
600V_{DC}			
20 189 28	NH00, DIN 80 (IEC 60 269-6)	No blown fuse indication	
20 189 29		With blown fuse indication	
20 412 29		With fitting for microswitch	
1000V_{DC}			
50 215 28	10x38mm	No blown fuse indication (1A - 22.4A)	
50 216 28	10x38mm - PCB Mount		
50 217 28	10x38mm - 50.6mm mounting centers		
50 218 28	10x38mm - For cable connection		
50 214 06	14x51mm (ground fault)	With blown fuse indication (1A - 5A)	
20 556 29	NH1 (IEC 60 269-6)	With blown fuse indication (50A - 200A)	
20 557 29	NH2 (IEC 60 269-6)	With blown fuse indication (200A - 250A)	
20 568 29	NH3 (IEC 60 269-6)	With blown fuse indication (200A - 400A)	
20 545 27	SQB-DC102 (IEC 60 269-6)	With blown fuse indication (200A - 400A)	
20 544 27	SQB-DC101 (IEC 60 269-6)	With blown fuse indication (70A - 300A)	
1100V_{DC}			
50 235 28	14x65mm	(8A - 25A)	
50 237 28	14x65mm - 77.5mm mounting centers		
50 238 28	10/14x85mm clip mounting		
50 239 28	14x65mm for cable connection		
20 019 27	SQB1-M8	With fitting for microswitch (35A - 200A)	
20 019 28		No blown fuse indication (35A - 200A)	
20 028 28	NH1XL (IEC 60 269-6)	No blown fuse indication (35A - 200A)	
20 028 29		With fitting for microswitch (35A - 200A)	
20 031 28	NH3L	No blown fuse indication (200A - 400A)	
20 031 29		With fitting for microswitch (200A - 400A)	
20 034 28	SQB2 - US Short	No blown fuse indication (200A - 450A)	
20 034 29		With fitting for microswitch (200A - 450A)	
1500V_{DC}			
50 240 28	14x65mm	(10A - 30A)	
50 242 28	14x65mm-80mm		
50 243 28	10/14x85mm clip mounting		
50 115 28	10.3mm x 85mm	(1A - 16A)	
50 260 28	22x65mm	(40A - 50A)	
50 262 28	22x65mm With Bolted Contacts		
20 041 28	SQB1 (Knife)	No blown fuse indication (50A - 200A)	
20 041 29		With blown fuse indication (50A - 200A)	
20 045 28	SQB1 (Bolted)	No blown fuse indication (50A - 200A)	
20 243 28	NH3L	No blown fuse indication (200A - 500A)	
20 243 29		With blown fuse indication (200A - 500A)	
20 247 28	SQB3-Bolted	No blown fuse indication (200A - 500A)	
20 247 27		With blown fuse indication (200A - 500A)	
20 245 28	SQB3-DIN	No blown fuse indication (200A - 500A)	
20 245 29		With blown fuse indication (200A - 500A)	

Higher voltages and currents are available, consult with SIBA for more information.



Energy Storage Fuses Product Overview

 SIBA Energy Storage (ESS) Fuse Offering			
Article Number	Description	Image	
150V_{DC} Battery Fuses			
50 054 38	35 x 59 mm	100A-450A	
50 071 38	2 x 35 x 59 mm	300A-900A	
250V_{DC} Battery Fuses			
50 048 38	BS 17.5mm x 21mm-41.8mm mm	12A-180A	
50 050 38	17.5mm x 25.5mm Solder Contacts	12A-180A	
50 154 36	22 x 58 mm	12A-160A	
50 155 36	22 x 58 mm - 80mm Bolted	12A-160A	
900V_{DC} Breaking capacity 226kA (L/R=2.7ms)			
50 204 34	14mm x 51 mm Full Range	10A - 25A	
50 205 34	14mm x 51 mm Bolted Full Range		
20 556 34	SQB1-DC-082	32A - 160A	
20 545 34	SQB1-DC-082	63A - 350A	
20 7xx 32	SQB1-3	50A - 800A	
20 031 34	NH3L W/O Indicator Full Range	125A-630A	
20 034 33	SQB-DC93 DIN W/O Ind Full Range		
20 034 34	SQB-DC93 DIN W Ind Full Range		
20 035 33	SQB-DC93 Bolted W/O Ind Full Range		
20 035 35	SQB-DC93 Bolted W Ind Full Range		
20 036 33	SQB-DC93 M12 W/O Ind Full Range		
20 036 35	SQB-DC93 M12 W Ind Full Range		
1000V_{DC} Breaking capacity 200kA			
50 196 10	27mmx60mm	20A-170A	
90 080 10	20mmx127mm	1-63A	

Higher voltages and currents are available, consult with SIBA for more information.











Energy Storage Fuses Product Overview

 SIBA Energy Storage (ESS) Fuse Offering			
Article Number	Description		Image
1000V_{DC} Breaking capacity 200kA			
20 585 21	NH0	63A - 200A	
90 223 38	SQB-DC0	100A - 200A	
90 540 25	SQB-DC101	63A - 400A	
90 280 26	SQB3-70 With center indicator M12	400A - 630A	
90 281 25	SQB3-70 Without indicator US Balde		
90 281 26	SQB3-70 With center inidicator US blade		
90 388 21	SQB-DC93-2 (Double Body Full Rage)	900A - 1100A	
90 290 25	SQB4 2x M12 without indicator	1000A - 1600A	
90 290 26	SQB4 2x M12 with center indicator		
90 291 25	SQB4 4x M10 without indicator		
90 291 26	SQB4 4x M10 with center indicator		
1200V_{DC}			
50 240 34	14mm x 65mm Full Range	10A - 25A	
50 242 34	14mm x 65mm Bolted Full Range		
20 243 33	10/14 x 85mm clip mounting Full Range		
20 028 34	NH1XL with Flap Indicator	50A - 200A 1200VDC (L/R = 10ms)	
20 029 34	NH1XL with Flap Indicator (bolted)		
90 203 38	SQB-DC2 without indicator	250A - 315A 1200VDC (L/R = 15ms)	
90 203 39	SQB-DC2 with center indicator	250A - 315A 1200VDC (L/R = 15ms)	
90 213 38	SQB-DC2-2 without indicator	500A - 630A 1200VDC (L/R = 15ms)	
90 213 39	SQB-DC2-2 with center indicator		
20 243 33	NH3L without Flap Indicator Full Range	200A - 500A 1200VDC (L/R = 10ms)	
20 243 34	NH3L with Flap Indicator Full Rage		
20 245 33	SQB3 Bladed w/o Indicator Full Range	200A - 500A 1200VDC (L/R = 10ms)	
20 245 34	SQB3 Bladed with Indicator Full Range		
20 247 33	SQB3 US Blade w/o Indicator Full Range		
20 247 35	SQB3 US Blade with Indicator		
20 248 33	SQB3 M12 w/o Indicator Full Range		
20 248 35	SQB3 M12 with Indicator Full Range		
90 390 25	SQB4 2x M12 without indicator	1000A - 2000A	
90 390 26	SQB4 2x M12 with center indicator	Double body 4000A is available	
90 391 25	SQB4 4x M12 without indicator	1000A - 2000A	
90 391 26	SQB4 4x M12 with center indicator	Double body 4000A is available	

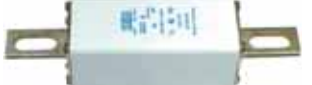
Higher voltages and currents are available, consult with SIBA for more information.

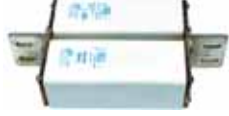

Energy Storage Fuses **Product Overview**

 SIBA Energy Storage (ESS) Fuse Offering			
Article Number	Description	Image	
1500V_{DC}			
50 270 06	27 x 85		
50 271 06	27 x 85 (SM140)		
90 445 26	SQB1 Bladed without Indicator	50A-200A	
90 223 38	SQB-DC0	100A - 200A	
90 203 38	SQB-DC2 without indicator	125A - 400A	
90 203 39	SQB-DC2 without indicator		
90 213 38	SQB-DC2 x2 without indicator	400A - 800A	
90 213 39	SQB-DC2 x 2 without indicator		
90 443 25	NH3L without Flap Indicator	200A-750A	
90 443 26	NH3L with Flap Indicator		
90 447 25	SQB3 Bladed US Short without Indicator	200A-750A	
90 447 27	SQB3 Bladed US Short with MS Adaptor		
90 448 25	SQB3 Bladed without Indicator	200A-750A	
90 448 26	SQB3 Bladed with Indicator		
90 392 25	SQB4 2x M12 without indicator	900A - 1500A	
90 392 26	SQB4 2x M12 with center indicator		
90 393 25	SQB4 4x M12 without indicator	900A - 1500A	
90 393 26	SQB4 4x M12 with center indicator		

Higher voltages and currents are available, consult with SIBA for more information.



Product Overview

PN: 30 287 13



To Grid

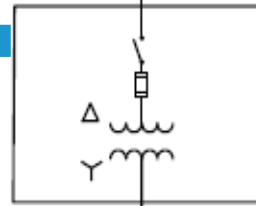

PN: 90 393 26



PN: 90 223 38



PN: 20 738 32



Inverter

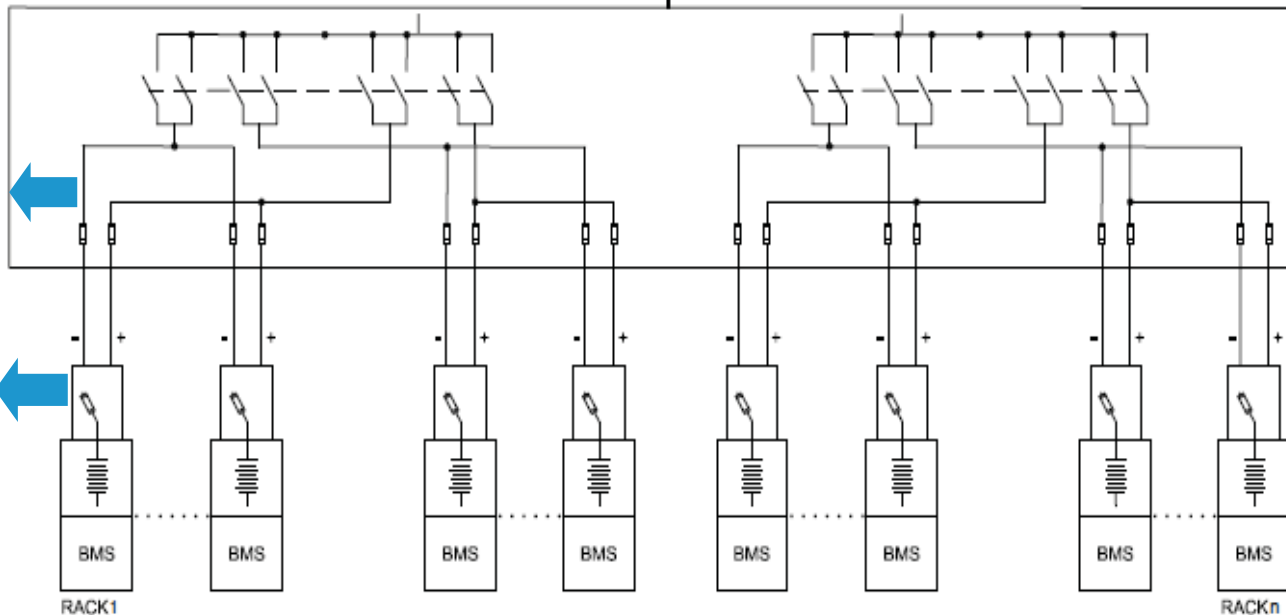

PN: 50 050 38



Perfect solutions for your energy storage units
SIBA fuses in battery installations

Our Protection.
Your Benefit.





Solar Fuses and Accessories **Product Overview**

URPV UL 2579 		SIBA Battery Fuses / SIBA Fuse DC Accessories	
Article Number	Description		Image
Accessories - Fuse Modules			
5106305.1DC	Fuse Module 10x38mm 1-Pole, 1000V _{DC}	No blown fuse indication (30A - 4W)	
5106305.1LDC		w/ Neon Lamp Indicator (30A - 4W)	
5106305.2DC	Fuse Module 10x38mm 2-Pole, 1000V _{DC}	No blown fuse indication (30A - 4W)	
5106305.2LDC		w/ Neon Lamp Indicator (30A - 4W)	
5105805.1SDC	Fuse Module 14x51mm 1-Pole, 1000V _{DC}	w/ Microswitch (50A - 6W)	
Accessories - Fuse Base			
2118928	Fuse Base NH00 DIN80, 600V _{DC}	For use with microswitch (200A)	
2119028	Fuse Base NH00 DIN80, 600V _{DC}	With terminal covers (200A)	
2155628	Fuse Base NH1, 1000V _{DC}	250A	
2102828	Fuse Base NH1XL, 1500V _{DC}	250A	
2155728	Fuse Base NH2, 1000V _{DC}	400A	
2156828	Fuse Base NH3, 1000V _{DC}	600A	
2103128	Fuse Base NH3L, 1500V _{DC}	600A	
5123805	Fuse base 10/14x85mm fuses1500V _{DC}	32A	
2800201	Microswitch For NH NH00 DIN80 SQB1-3	250Vac/5A 33Vdc/3A, 26Vdc/3A	
2800202	Microswitch For NH Combi-Indicator & NH000 DIN80 (Red Hammer) NH000 - 4	250Vac/5A 33Vdc/3A, 26Vdc/3A	
Accessories - Fuse Clips			
5806316	10mm, PCB mounting (clips)		
5806319	10mm, PCB mounting (clips)		
5806317	10mm, screw mounting (clips)		
6301701	Clamping plate for 58 063 17		
6301701.3	Terminal link for 58 063 17		
6100101.2	14mm, screw mounting		
6301701	Clamping plate for 60 001 01.2		
Fuse Clips			
5805806	14mm, PCB mounting		
Grip Handle - Fuse Insertion-Removal Tool			
2200102	NH00 -3, 690V _{AC}	Standard	
2200105		w/Leather Sleeve	
2203101	NH3, 1600V _{AC}	Standard	
2203102	NH3, 1600V _{AC}	w/Leather Sleeve	
2212001	NH4a & NH4, 690V _{AC}	Handle only	

Higher voltages and currents are available, consult with SIBA for more information.

SIBA



SIBA
FUSES



ABOUT SIBA FUSES

Our protection is your benefit. SIBA has over 70 years of history in developing a global product line which is supported by efficient worldwide offices, local technical assistance and a vast distribution network. Our products work in the background, unobtrusively protecting your personnel, equipment and your investments. Our own proprietary product developments and meticulous monitoring of our production ensure that our fuses are of the best quality. Our products come into action before any major damage can occur. Seen in this light, SIBA fuses are an important investment.

SIBA FUSES is proud to introduce our new product line of Energy Storage (ES) fuses that features a high breaking capacity for low L/R, specifically designed to meet the stringent requirements for energy storage applications. Voltages range from 800VDC - 4200VDC +. Fuses come with a wide range of mounting options.

EV fuses: Automotive electrical fuses: SIBA is the world #1 in EV fuses supplying fuses for the most prestigious EV manufacturers where a SIBA fuse can be found in every new electrical vehicle.

SIBA - Safety through quality. Superior engineering for circuit protection.

SIBA Fuse products are designed and manufactured to a variety of major international standards such as: UL/CSA/IEC/DIN/BS and NF. The design and manufacturing operation in Germany is DIN EN ISO 9001 and DIN EN ISO 14001.

Phone: 973-575-7422
Fax: 973-575-5858
Email: info@sibafuse.com
SIBA LLC
29 Fairfield Place
West Caldwell, NJ 07006 USA

SOLAR, WIND & ENERGY STORAGE



**Our Protection.
Your Benefit.**

Request 2019 Catalog:
info@sibafuse.com